

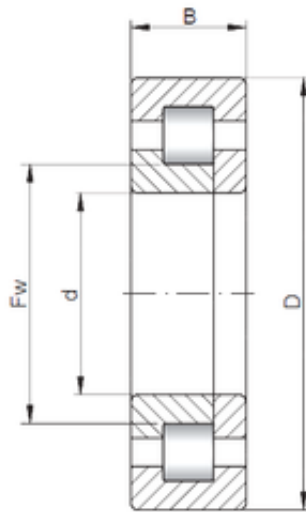

JieFei Bearing Co., Ltd



170 mm x 260 mm x 54 mm ISO NUP2034
cylindrical roller bearings

Bearing No. NUP2034

Size	170x260x54 mm
Bore Diameter	170 mm
Outer Diameter	260 mm
Width	54 mm
d	170 mm
D	260 mm
B	54 mm
C	54 mm

NUP2034 Bearing 2D drawings and 3D CAD models